

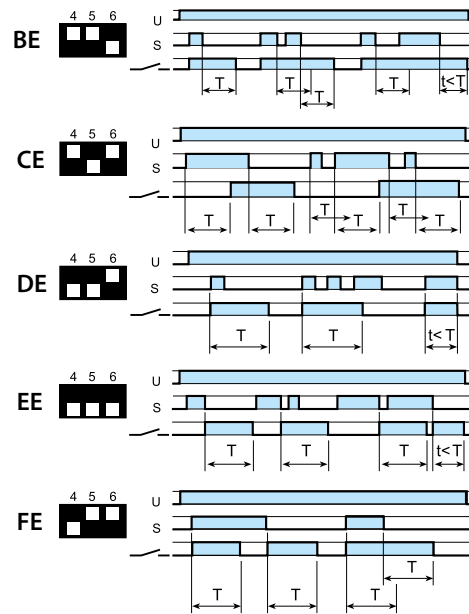

86.00

86.00.0.240.0000	
	U _N (12...240)V AC (50/60 Hz) / DC U _{min} 10.2 V AC/DC U _{max} 265 V AC/DC P 1.2 W
	(-20...+50)°C
IP20	

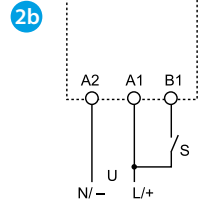
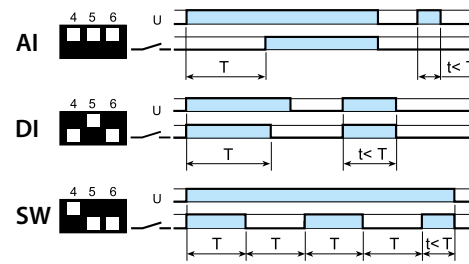
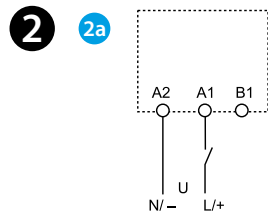
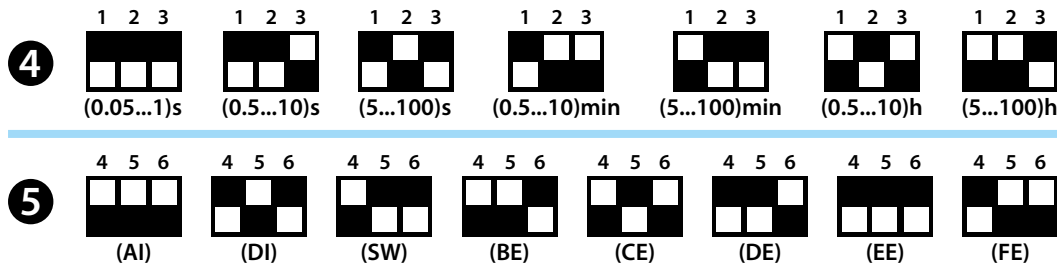
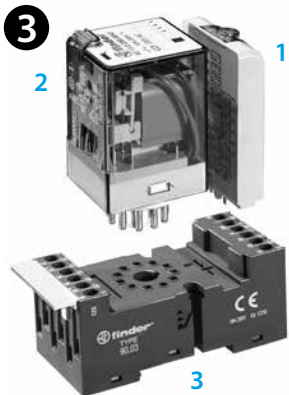
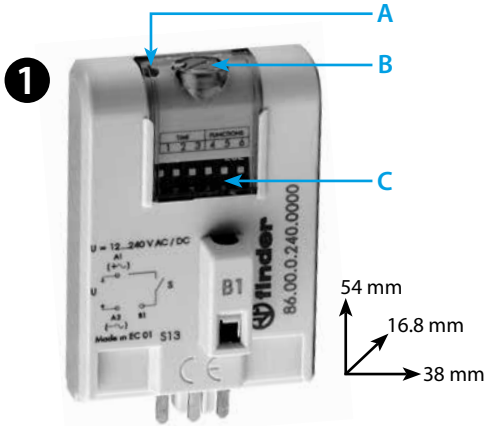

NEDERLANDS

86.00
TIJDMODULE MULTIFUNCTIE MET MULTISPANNING

- 1 FRONTAANZICHT**
A LED
B Potentiometer voor tijdstelling
C Dip schakelaar: tijdbereiken en functies

- 2 AANSLUITSCHEMA / FUNCTIES**
2a Aansluitingen start in de voedingsleiding naar A1
 AI Vertraagd-opkomend
 DI Inschakel-wissend
 SW Impulsrelais impulsbeginnend
2b Aansluitingen start in de stuurleiding naar B1
 BE Vertraagd-afvallend
 CE Inschakel-en afvalvertraagend
 DE Inschakel-wissend
 EE Uitschakel-wissend
 FE Inschakel-/ Uitschakel-wissend

- 3 INSTALLATIE (Voorbeeld)**
 1 Tijdmodule
 2 Relais
 3 Aansluitvoet

	1	2	3
	86.00	56.34	96.04
	86.00	60.12	90.02
	86.00	60.13	90.03
	86.00	62.32	92.03
	86.00	62.33	92.03

- 4** DIP "TIME"
5 DIP "FUNCTIONS"